

LMS78_0.5R Series

Wide Input Non-Isolated & Regulated, Single Positive/Negative Output

Switching Regulator

- ⊕ Efficiency up to 93%
- ⊕ Operating temperature range: -40°C ~ +85°C
- ⊕ Pin-out compatible with LM78xx linears
- ⊕ Short circuit protection (SCP)
- ⊕ Thermal shutdown
- ⊕ Low ripple and noise
- ⊕ Sip package, meet UL94-V0
- ⊕ Low temperature rise
- ⊕ Industry standard pinout
- ⊕ Ultra low no-load power consumption

The LMS78_0.5R series high efficiency switching regulators are ideally suited to replace LM78xx linear regulators and are pin compatible.



Common specifications	
Short circuit protection:	Continuous, automatic recovery
No-load input current:	0.2mA TYP, 1.5mA MAX
Reverse Polarity Input:	Forbidden
Input Filter:	Capacitor Filter
Temperature rise at full load:	25°C MAX, 15°C TYP
Cooling:	Free air convection
Operation temperature range:	-40°C~+85°C Power derating above 71°C
Storage temperature range:	-55°C ~+125°C
Pin welding resistance temperature:	260°C MAX, 1.5mm from case for 10 sec
Operating case temperature:	100°C
Storage humidity range:	< 95%RH
Package material:	Plastic [UL94-V0]
MTBF:	>2,000,000 hours +25°C MIL-HDBK-217F
Weight:	2g

Output specifications						
Item	Test conditions	Min	Typ	Max	Units	
Output voltage accuracy	100% load		±2	±3	%	
Line regulation	Input Voltage Range		±0.2	±0.4	%	
Load regulation	10% to 100% load		±0.4	±0.6	%	
Output current limit				3000	mA	
Ripple + Noise*	20MHz Bandwidth Vin=24VDC 0% -100% load		20	75	mVp-p	
Over heat protection	Internal IC junction			170	°C	
Short circuit input power			0.5	1.8	W	
Switching frequency			550	850	KHz	
Transient response deviation	Nominal input, 25% load step change		55	250	mV	
Transient recovery time	Nominal input, 25% load step change		0.5	2	ms	
Temperature coefficient	-40 °C to +85 °C ambient			0.03	%/°C	

Note:

1. The max. capacitive load should be tested within the input voltage range and under full load conditions;
2. Without any special statement, all indexes are only specific to positive output application;
3. Unless otherwise specified, data in this datasheet should be tested under the conditions of Ta = 25°C, humidity <75% when inputting nominal voltage and outputting rated load;
4. All index testing methods in this datasheet are based on our Company's corporate standards;
5. The performance indexes of the product models listed in this manual are as above, but some indexes of non-standard model products will exceed the above-mentioned requirements, and please directly contact with our technician for specific information;
6. Specifications subject to change without prior notice.

* Test ripple and noise by "parallel cable" method. With the load lower than 10%, maximum ripple and noise will be 150mVp-p.

Example:

LMS78_05-0.5R

LM = Series; S = SIP Case; 05 = 5Vout; 0.5 = 0.5A; R = Revised

EMC specifications					
EMI	CE	CISPR22/EN55022	CLASS B	(External circuit refer to EMC recommended circuit, ② or EMC module application circuit)	
EMI	RE	CISPR22/EN55022	CLASS B	(External circuit refer to EMC recommended circuit, ② or EMC module application circuit)	
EMS	ESD	IEC/EN61000-4-2	Contact ±4KV	perf. Criteria B	
EMS	RS	IEC/EN61000-4-3	10V/m	perf. Criteria A	
EMS	EFT	IEC/EN61000-4-4	±2KV	perf. Criteria B (External circuit refer to EMC recommended circuit, ①)	
EMS	CS	IEC/EN61000-4-6	3 Vr.m.s	perf. Criteria A	
EMS	Voltage dips, short and interruptions immunity	IEC/EN61000-4-29	0%-70%	perf. Criteria B	

LMS78_0.5R Series

Wide Input Non-Isolated & Regulated, Single Positive/Negative Output

Part Number	Input Voltage [VDC] Nominal (Range)	Output Voltage [VDC]	Output Current [mA]	Efficiency [%, min/typ]	Max. capacitive load [μF]
LMS78_03-0.5R	24 (4.75-36)	3.3	500	78/81	680
LMS78_05-0.5R	24 (6.5-36) 12 (7-31)	5 -5	500 -300	82/85 78/81	680 330
LMS78_09-0.5R	24 (12-36)	9	500	87/90	680
LMS78_12-0.5R	24 (15-36) 12 (8-24)	12 -12	500 -150	89/92 82/85	680 330
LMS78_15-0.5R	24 (19-36) 12 (8-21)	15 -15	500 -150	90/93 82/85	680 330

Typical characteristics

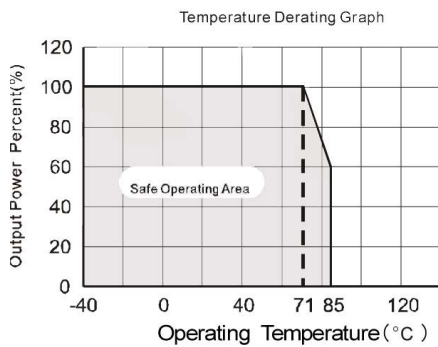

Typical application circuit

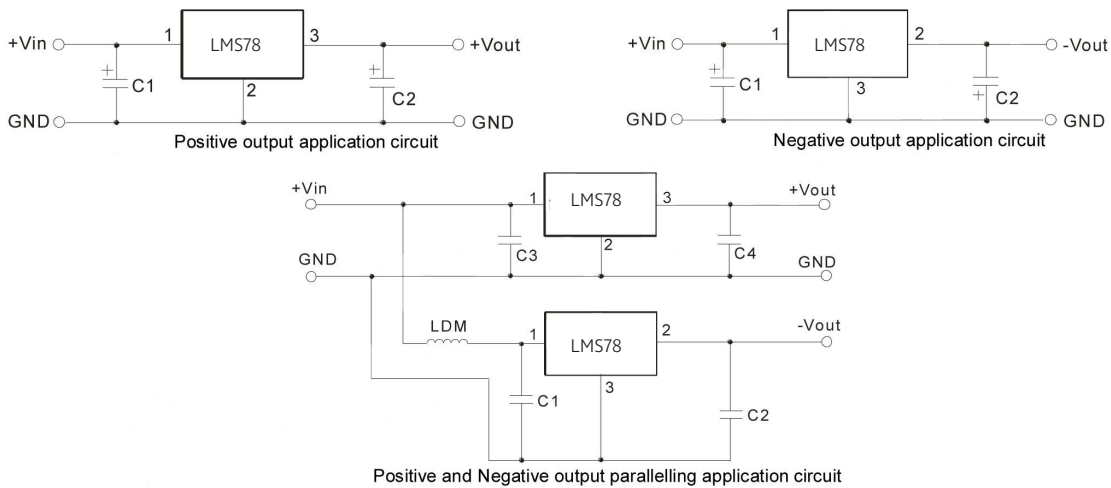

Part number	C1,C3 (Ceramic Capacitor)	C2,C4 (Ceramic Capacitor)
LMS78_03-0.5R	10μF/50V	22μF/10V
LMS78_05-0.5R	10μF/50V	22μF/10V
LMS78_09-0.5R	10μF/50V	22μF/16V
LMS78_12-0.5R	10μF/50V	22μF/25V
LMS78_15-0.5R	10μF/50V	22μF/25V

Note:

1. C1 and C2 are required and should be connected close to the pin terminal of the module.
2. The capacitance of C1 and C2 refer to Sheet 1, it can be increased properly if required, and tantalum or low ESR electrolytic capacitors may also suffice.
3. When the products used as the circuit like figure 3, an inductor named as LDM up to 10μH is recommended in the circuit to reduce the mutual interference.
4. Cannot be used in parallel for output and hot swap.
5. Operation under no load will not damage these devices, however they may not meet all specifications. In order to ensure the converter can work reliably with high efficiency, please parallel a resistor on the output side (The sum of the efficient power and resistor consumption power is not less than 10%).

LMS78_0.5R Series

Wide Input Non-Isolated & Regulated, Single Positive/Negative Output

Typical application circuit

To reduce the output ripple furtherly, it is suggested to connect a "LC" filter at the output terminal, and recommended value of L is 10μH-47μH.

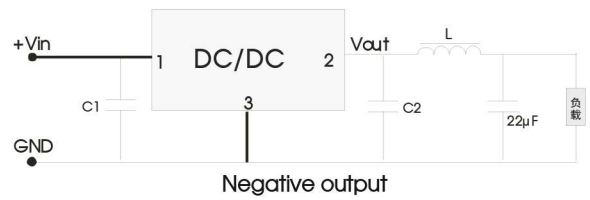
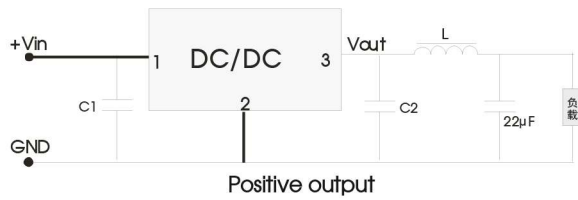

EMC solution-recommended circuit

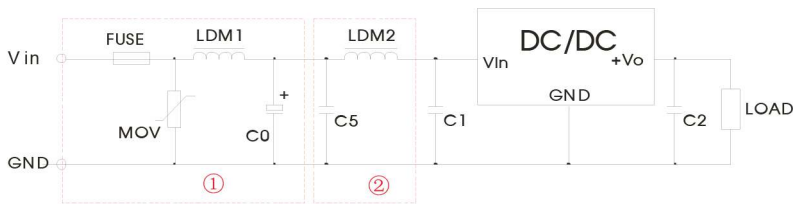

Part ① in the Fig. 5 is for EMS test, part ② is for EMI filtering; parts ☒ and ☒ can be added based on actual requirement.

FUSE	MOV	LDM1	C0	C1/C2	C5	LDM2
Selected based on the actual input current from the customer	S10K35	82μH	680μF /50V	Refer to table above	4.7μF /50V	12μH

Mechanical dimension and footprint

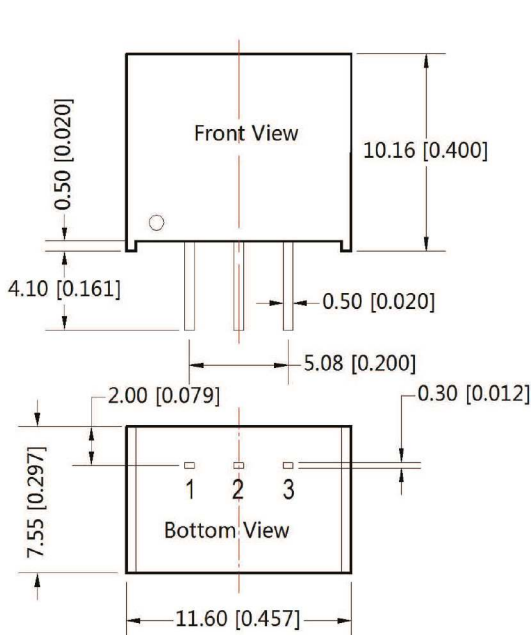

THIRD ANGLE PROJECTION

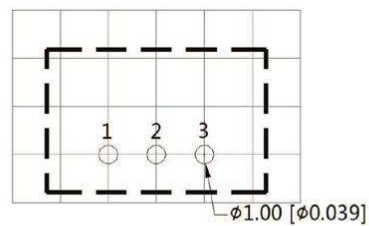

Note : Grid 2.54*2.54mm

Pin-Out		
Pin	Positive Output	Negative Output
1	Vin	Vin
2	GND	-Vo
3	+Vo	GND

Note:
Unit :mm[inch]
Pin section tolerances:±0.10[±0.004]
General tolerances:±0.25[±0.010]