



ON Semiconductor®

J111 / J112 / J113 / MMBFJ111 / MMBFJ112 / MMBFJ113 N-Channel Switch

Features

- This device is designed for low level analog switching, sample and hold circuits and chopper stabilized amplifiers.
- Sourced from process 51
- Source & Drain are interchangeable.

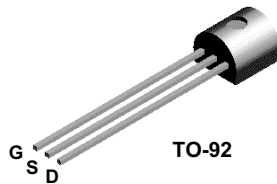

Figure 1. J111 / J112 / J113 Device Package

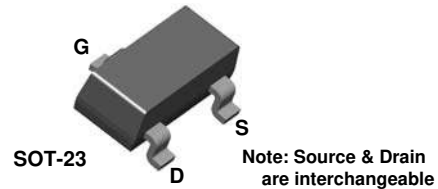

Figure 2. MMBFJ111 / MMBFJ112 / MMBFJ113 Device Package

Ordering Information

| Part Number | Top Mark | Package | Packing Method |
|-------------|----------|-----------|----------------|
| J111 | J111 | TO-92 3L | Bulk |
| J111-D26Z | J111 | TO-92 3L | Tape and Reel |
| J111-D74Z | J111 | TO-92 3L | Ammo |
| J112 | J112 | TO-92 3L | Bulk |
| J112-D26Z | J112 | TO-92 3L | Tape and Reel |
| J112-D27Z | J112 | TO-92 3L | Tape and Reel |
| J112-D74Z | J112 | TO-92 3L | Ammo |
| J113 | J113 | TO-92 3L | Bulk |
| J113-D74Z | J113 | TO-92 3L | Ammo |
| J113-D75Z | J113 | TO-92 3L | Ammo |
| MMBFJ111 | 6P | SOT-23 3L | Tape and Reel |
| MMBFJ112 | 6R | SOT-23 3L | Tape and Reel |
| MMBFJ113 | 6S | SOT-23 3L | Tape and Reel |

J111 / J112 / J113 / MMBFJ111 / MMBFJ112 / MMBFJ113 — N-Channel Switch

Absolute Maximum Ratings^{(1), (2)}

Stresses exceeding the absolute maximum ratings may damage the device. The device may not function or be operable above the recommended operating conditions and stressing the parts to these levels is not recommended. In addition, extended exposure to stresses above the recommended operating conditions may affect device reliability. The absolute maximum ratings are stress ratings only. Values are at $T_A = 25^\circ\text{C}$ unless otherwise noted.

| Symbol | Parameter | Value | Unit |
|----------------|--|------------|------------------|
| V_{DG} | Drain-Gate Voltage | 35 | V |
| V_{GS} | Gate-Source Voltage | -35 | V |
| I_{GF} | Forward Gate Current | 50 | mA |
| T_J, T_{STG} | Operating and Storage Junction Temperature Range | -55 to 150 | $^\circ\text{C}$ |

Notes:

1. These ratings are based on a maximum junction temperature of 150°C .
2. These are steady-state limits. ON Semiconductor should be consulted on applications involving pulsed or low-duty-cycle operations.

Thermal Characteristics

Values are at $T_A = 25^\circ\text{C}$ unless otherwise noted.

| Symbol | Parameter | Max. | | Unit |
|-----------------|---|-----------------------------------|---|---------------------------|
| | | J111 / J112 / J113 ⁽³⁾ | MMBFJ111 / MMBFJ112 / MMBFJ113 ⁽⁴⁾ | |
| P_D | Total Device Dissipation | 625 | 350 | mW |
| | Derate Above 25°C | 5.0 | 2.8 | mW/ $^\circ\text{C}$ |
| $R_{\theta JC}$ | Thermal Resistance, Junction-to-Case | 125 | | $^\circ\text{C}/\text{W}$ |
| $R_{\theta JA}$ | Thermal Resistance, Junction-to-Ambient | 200 | 357 | $^\circ\text{C}/\text{W}$ |

Notes:

3. PCB size: FR-4, 76 mm x 114 mm x 1.57 mm (3.0 inch x 4.5 inch x 0.062 inch) with minimum land pattern size.
4. Device mounted on FR-4 PCB 36mm x 18mm x 1.5mm; mounting pad for the collector lead minimum 6cm².

Electrical Characteristics

Values are at $T_A = 25^\circ\text{C}$ unless otherwise noted.

| Symbol | Parameter | Conditions | Min. | Max. | Unit | |
|-------------------------------------|--|---|------|------|-------|----------|
| Off Characteristics | | | | | | |
| $V_{(BR)GSS}$ | Gate-Source Breakdown Voltage | $I_G = -1.0 \mu\text{A}$, $V_{DS} = 0$ | -35 | | V | |
| I_{GSS} | Gate Reverse Current | $V_{GS} = -15 \text{ V}$, $V_{DS} = 0$ | | -1.0 | nA | |
| $V_{GS(off)}$ | Gate-Source Cut-Off Voltage | $V_{DS} = 15 \text{ V}$, $I_D = 1.0 \mu\text{A}$ | 111 | -3.0 | -10.0 | V |
| | | | 112 | -1.0 | -5.0 | |
| | | | 113 | -0.5 | -3.0 | |
| $I_{D(off)}$ | Drain Cutoff Leakage Current | $V_{DS} = 5.0 \text{ V}$, $V_{GS} = -10 \text{ V}$ | | 1.0 | nA | |
| On Characteristics | | | | | | |
| I_{DSS} | Zero-Gate Voltage Drain Current ⁽⁵⁾ | $V_{DS} = 15 \text{ V}$, $V_{GS} = 0$ | 111 | 20 | | mA |
| | | | 112 | 5.0 | | |
| | | | 113 | 2.0 | | |
| $r_{DS(on)}$ | Drain-Source On Resistance | $V_{DS} \leq 0.1 \text{ V}$, $V_{GS} = 0$ | 111 | | 30 | Ω |
| | | | 112 | | 50 | |
| | | | 113 | | 100 | |
| Small Signal Characteristics | | | | | | |
| $C_{dg(on)}$ $C_{sg(on)}$ | Drain-Gate & Source-Gate On Capacitance | $V_{DS} = 0$, $V_{GS} = 0$, $f = 1.0 \text{ MHz}$ | | 28 | pF | |
| $C_{dg(off)}$ | Drain-Gate Off Capacitance | $V_{DS} = 0$, $V_{GS} = -10 \text{ V}$, $f = 1.0 \text{ MHz}$ | | 5.0 | pF | |
| $C_{sg(off)}$ | Source-Gate Off Capacitance | $V_{DS} = 0$, $V_{GS} = -10 \text{ V}$, $f = 1.0 \text{ MHz}$ | | 5.0 | pF | |

Note:

5. Pulse test: pulse width $\leq 300 \mu\text{s}$, duty cycle $\leq 2\%$.

Typical Performance Characteristics

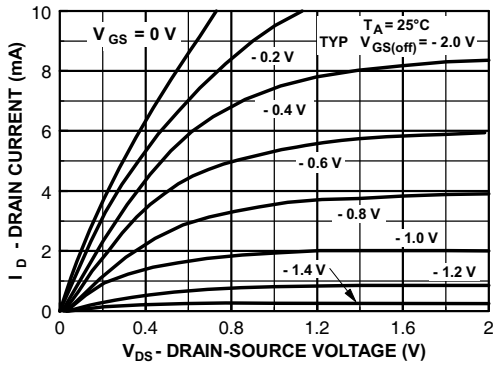

Figure 3. Common Drain-Source

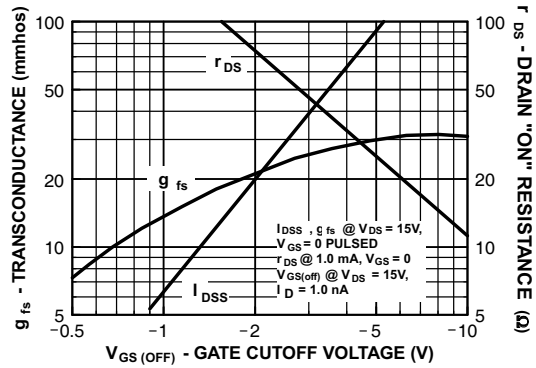

Figure 4. Parameter Interactions

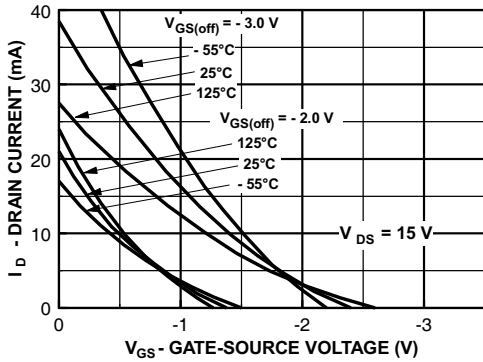

Figure 5. Transfer Characteristics

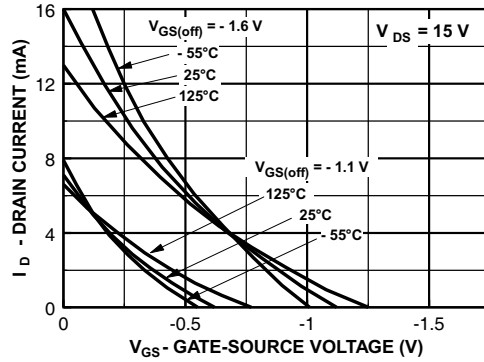

Figure 6. Transfer Characteristics

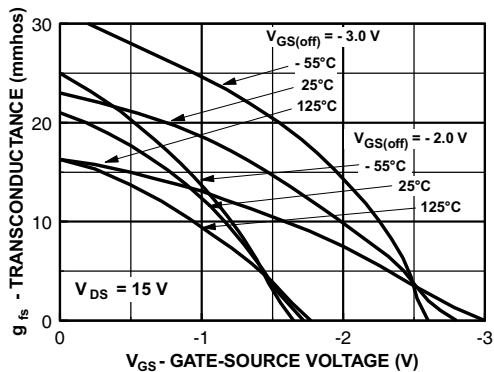

Figure 7. Transfer Characteristics

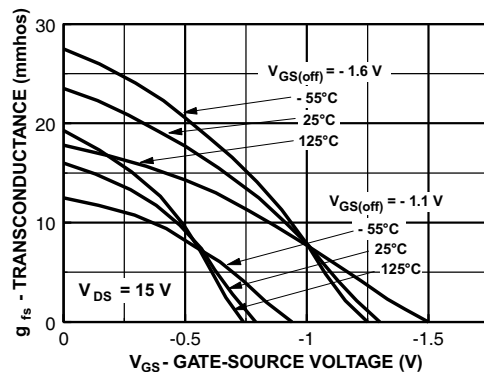

Figure 8. Transfer Characteristics

Typical Performance Characteristics (Continued)

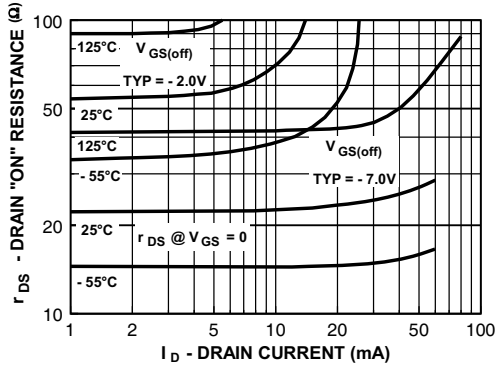

Figure 9. On Resistance vs. Drain Current

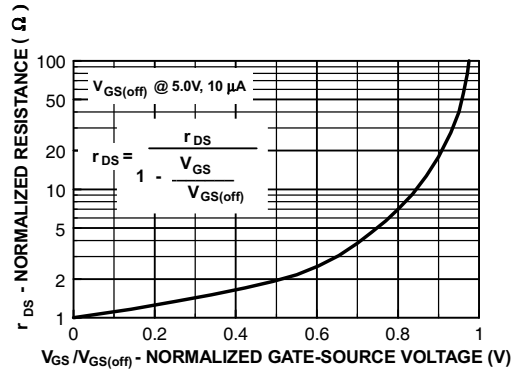

Figure 10. Normalized Drain Resistance vs. Bias Voltage

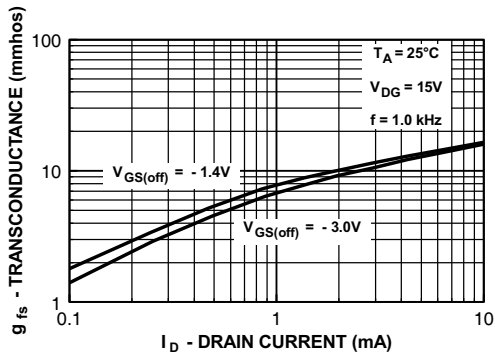

Figure 11. Transconductance vs. Drain Current

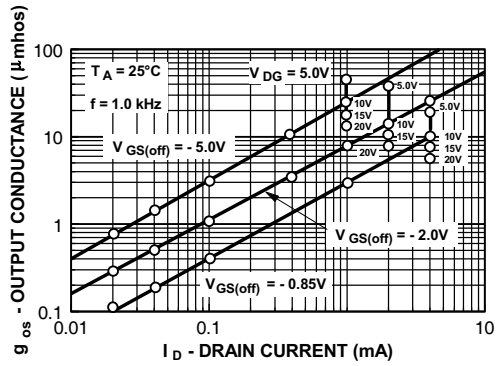

Figure 12. Output Conductance vs. Drain Current

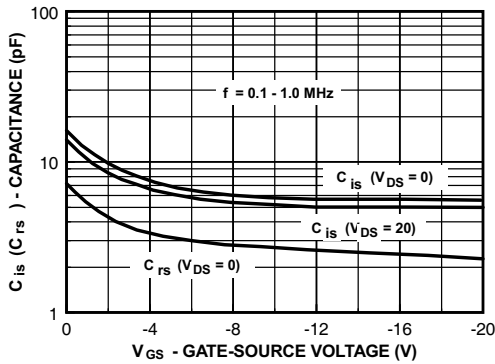

Figure 13. Capacitance vs. Voltage

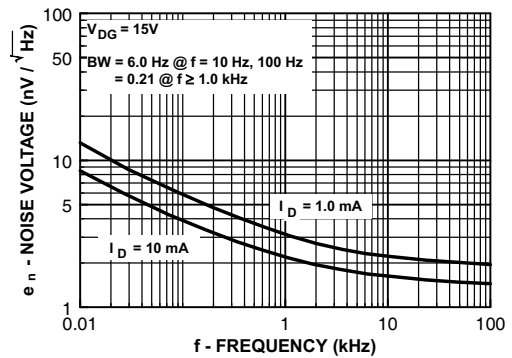

Figure 14. Noise Voltage vs. Frequency

Typical Performance Characteristics (Continued)

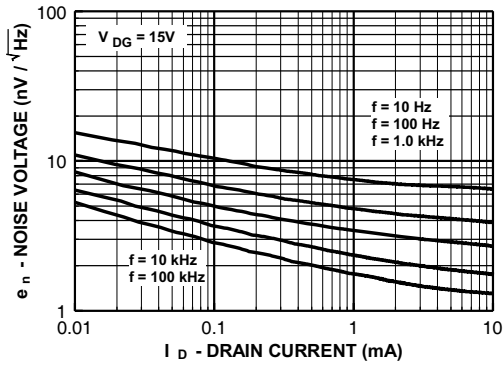

Figure 15. Noise Voltage vs. Current

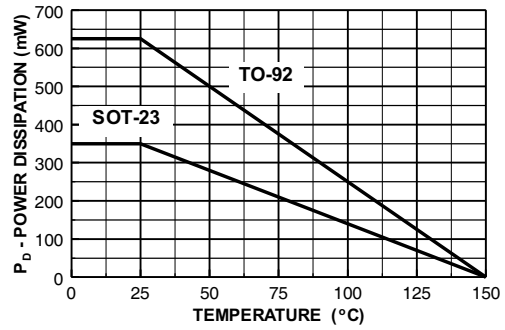

Figure 16. Power Dissipation vs. Ambient Temperature

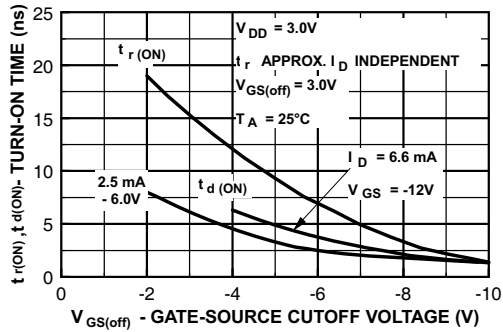

Figure 17. Switching Turn-On Time vs. Gate-Source Voltage

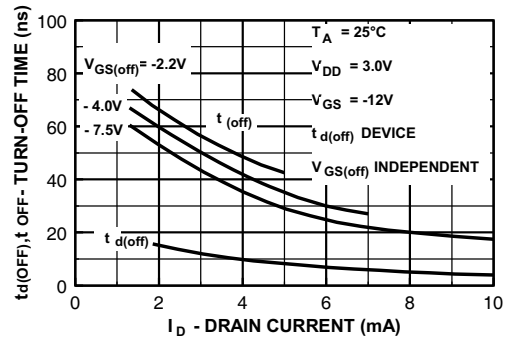
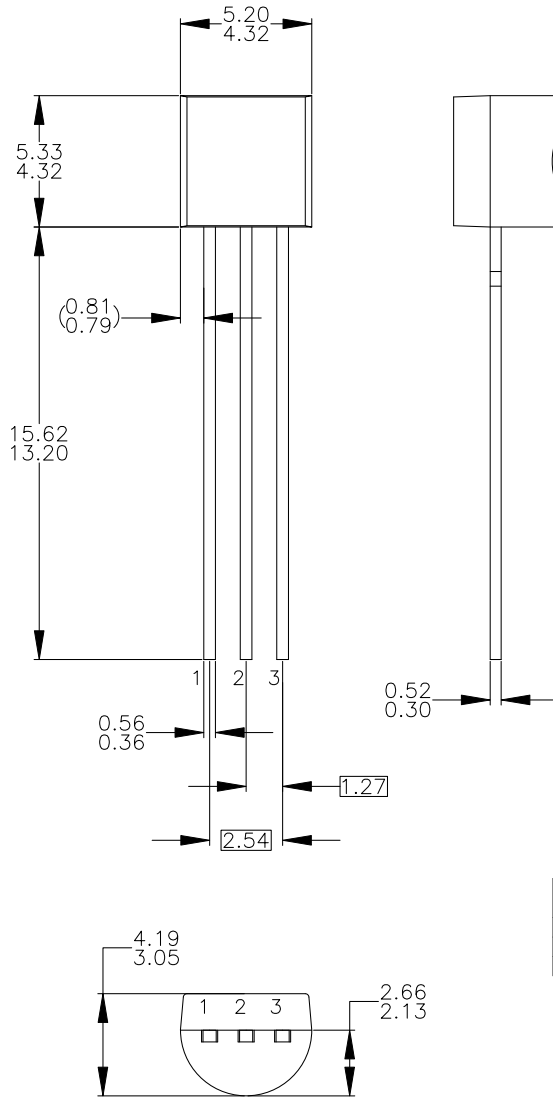

Figure 18. Switching Turn-Off Time vs. Drain Current

Physical Dimensions



NOTES: UNLESS OTHERWISE SPECIFIED

- A) DRAWING WITH REFERENCE TO JEDEC TO-92 RECOMMENDATIONS.
- B) ALL DIMENSIONS ARE IN MILLIMETERS.
- C) DRAWING CONFORMS TO ASME Y14.5M-1994.
- D) TO-92 (92,94,96,97,98) PIN CONFIGURATION:

| PIN | 92 | | | 94 | | | 96 | | | 97 | | | 98 | | |
|-----|----|---|---|----|---|---|----|---|---|----|---|---|----|---|---|
| | P | F | M | P | F | M | B | F | M | P | F | M | P | F | M |
| 1 | E | S | S | E | S | S | B | D | G | C | G | D | C | G | D |
| 2 | B | D | G | C | G | D | E | S | S | B | D | G | E | S | S |
| 3 | C | G | D | B | D | G | C | G | D | E | S | S | B | D | G |

LEGEND:

P - BIPOLAR E - EMITTER D - DRAIN
 F - JFET B - BASE S - SOURCE
 M - DMOS C - COLLECTOR G - GATE

- E) FOR PACKAGE 92, 94, 96, 97 AND 98:
 PIN CONFIGURATION DRAIN "D" AND SOURCE "S"
 ARE INTERCHANGEABLE AT JFET "F" OPTION.
- F) DRAWING FILENAME: MKT-ZA03DREV3.

Figure 19. 3-Lead, TO-92, JEDEC TO-92 Compliant Straight Lead Configuration, Bulk Type

Physical Dimensions (Continued)

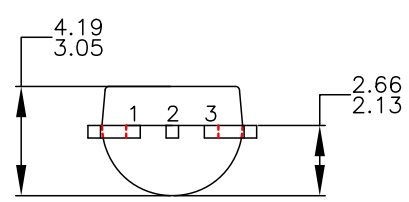
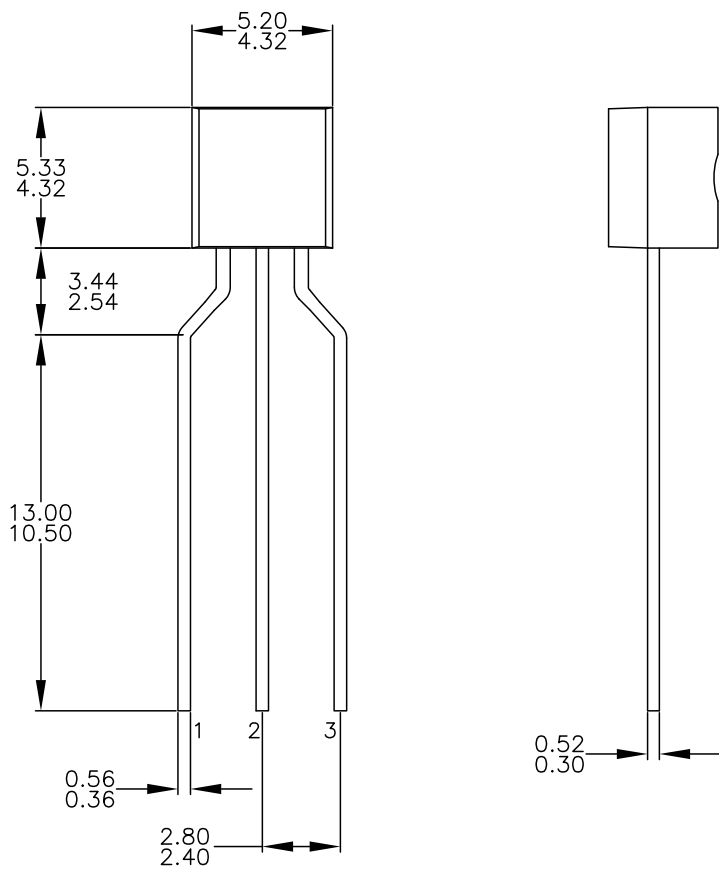

- NOTES: UNLESS OTHERWISE SPECIFIED
- A. DRAWING CONFORMS TO JEDEC MS-013, VARIATION AC.
 - B. ALL DIMENSIONS ARE IN MILLIMETERS.
 - C. DRAWING CONFORMS TO ASME Y14.5M-2009.
 - D. DRAWING FILENAME: MKT-ZA03FREV3.
 - E. ON SEMICONDUCTOR

Figure 20. 3-Lead, TO-92, Molded, 0.2 In Line Spacing Lead Form, Ammo, Tape and Reel Type

Physical Dimensions (Continued)

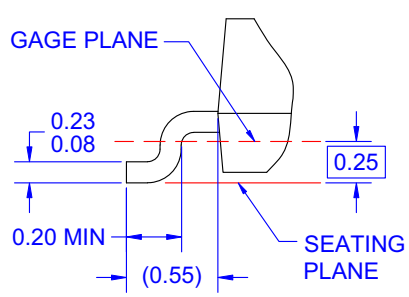
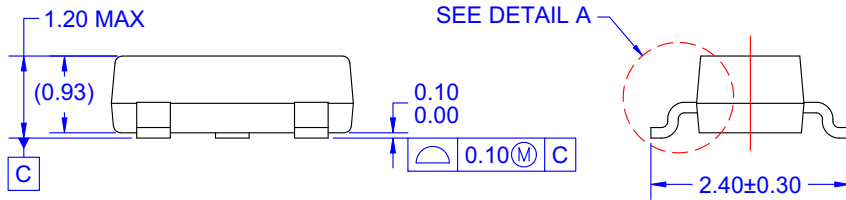
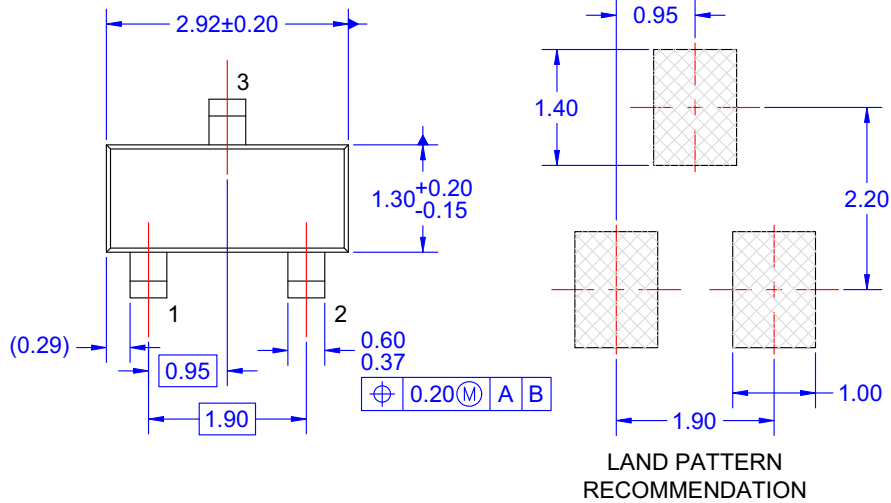

- NOTES: UNLESS OTHERWISE SPECIFIED
- A) REFERENCE JEDEC REGISTRATION TO-236, VARIATION AB, ISSUE H.
 - B) ALL DIMENSIONS ARE IN MILLIMETERS.
 - C) DIMENSIONS ARE INCLUSIVE OF BURRS, MOLD FLASH AND TIE BAR EXTRUSIONS.
 - D) DIMENSIONING AND TOLERANCING PER ASME Y14.5M - 1994.
 - E) DRAWING FILE NAME: MA03DREV10

DETAIL A
SCALE: 2X

Figure 21. 3-LEAD, SOT23, JEDEC TO-236, LOW PROFILE

ON Semiconductor and  are trademarks of Semiconductor Components Industries, LLC dba ON Semiconductor or its subsidiaries in the United States and/or other countries. ON Semiconductor owns the rights to a number of patents, trademarks, copyrights, trade secrets, and other intellectual property. A listing of ON Semiconductor's product/patent coverage may be accessed at www.onsemi.com/site/pdf/Patent-Marking.pdf. ON Semiconductor reserves the right to make changes without further notice to any products herein. ON Semiconductor makes no warranty, representation or guarantee regarding the suitability of its products for any particular purpose, nor does ON Semiconductor assume any liability arising out of the application or use of any product or circuit, and specifically disclaims any and all liability, including without limitation special, consequential or incidental damages. Buyer is responsible for its products and applications using ON Semiconductor products, including compliance with all laws, regulations and safety requirements or standards, regardless of any support or applications information provided by ON Semiconductor. "Typical" parameters which may be provided in ON Semiconductor data sheets and/or specifications can and do vary in different applications and actual performance may vary over time. All operating parameters, including "Typicals" must be validated for each customer application by customer's technical experts. ON Semiconductor does not convey any license under its patent rights nor the rights of others. ON Semiconductor products are not designed, intended, or authorized for use as a critical component in life support systems or any FDA Class 3 medical devices or medical devices with a same or similar classification in a foreign jurisdiction or any devices intended for implantation in the human body. Should Buyer purchase or use ON Semiconductor products for any such unintended or unauthorized application, Buyer shall indemnify and hold ON Semiconductor and its officers, employees, subsidiaries, affiliates, and distributors harmless against all claims, costs, damages, and expenses, and reasonable attorney fees arising out of, directly or indirectly, any claim of personal injury or death associated with such unintended or unauthorized use, even if such claim alleges that ON Semiconductor was negligent regarding the design or manufacture of the part. ON Semiconductor is an Equal Opportunity/Affirmative Action Employer. This literature is subject to all applicable copyright laws and is not for resale in any manner.

PUBLICATION ORDERING INFORMATION

LITERATURE FULFILLMENT:

Literature Distribution Center for ON Semiconductor
19521 E. 32nd Pkwy, Aurora, Colorado 80011 USA
Phone: 303-675-2175 or 800-344-3860 Toll Free USA/Canada
Fax: 303-675-2176 or 800-344-3867 Toll Free USA/Canada
Email: orderlit@onsemi.com

N. American Technical Support: 800-282-9855 Toll Free
USA/Canada
Europe, Middle East and Africa Technical Support:
Phone: 421 33 790 2910
Japan Customer Focus Center
Phone: 81-3-5817-1050

ON Semiconductor Website: www.onsemi.com
Order Literature: <http://www.onsemi.com/orderlit>

For additional information, please contact your local
Sales Representative