

Preliminary Data Sheet



T-57-11

915A Power Module: DC-DC Converter; 48 Vdc Input, 5 Vdc Output, 15 W

**10-15
WATTS**

The 915A Power Module features input-to-output isolation, allowing versatile polarity configurations and grounding connections.



Features

- Small size: 2.1" x 2.7" x 0.61"
- Meets FCC Class A requirements for telecommunications
- Output overvoltage clamp
- Short-circuit protection
- Input-to-output isolation
- Complete input and output filtering
- Operating ambient temperature range: 0 to 70°C
- No heat sink or derating required
- Printed circuit board mountable

Applications

- Telecommunications 48 V systems
- Local power distribution
- Digital circuits
- Distributed power architecture

Full Power With No Derating To 70°C

The 915A Power Module is a dc-dc converter that is suitable for a wide variety of applications. The module converts 48 Vdc to 5 Vdc and delivers 15 W at a full load efficiency of 78%, minimum. The precisely regulated output is fully isolated from the input, allowing versatile polarity configurations and grounding connections.

The module is potted in a nonconductive, plastic case that is designed for mounting on a printed circuit board. No external filtering components are required and no heat sink is required. In a natural convection environment, the module is rated to full load at 70°C.

T-57-11

Absolute Ratings

Exceeding these values can damage the module.

Parameter	Symbol	Min	Max	Unit
Input Voltage	V _I	—	60	Vdc
I/O Isolation Voltage		—	500	Vdc
Operating Ambient Temperature (Natural Convection)	T _A	0	70	°C
Storage Temperature		-40	+100	°C

Electrical Specifications

Unless otherwise indicated, specifications apply over all operating input voltage, resistive load, and temperature conditions.

Parameter	Symbol	Min	Typ	Max	Unit
Input					
Operating Input Voltage	V _I	40	48	60	Vdc
Maximum Input Current (V _I = 0 to 60 V) (see Figure 1)	I _{I, max}	—	—	940	mA
Inrush Transient	i ² t	—	—	0.54	A ² s
Input Reflected Ripple Current, Peak-to-Peak (5 Hz to 20 MHz, 12 μH source impedance) (see Figure 8)		—	12	—	mA p-p
Input Ripple Rejection (120 Hz)		—	75	—	dB

Fusing Considerations

This encapsulated power module can be used in a wide variety of applications ranging from simple stand-alone operation to an integrated part of a sophisticated power architecture. To preserve maximum flexibility, internal fusing is not included. However, to achieve maximum safety and system protection, an input line fuse should always be used. To aid the proper fuse selection for the given application, information on inrush energy and maximum dc input current is provided. Refer to the fuse manufacturer's data for further information.

T-57-11

Electrical Specifications (Continued)

Parameter	Symbol	Min	Typ	Max	Unit
Output					
Output Voltage (Over all operating input voltage, resistive load, and temperature conditions until end of life)	V_o	4.75	—	5.25	Vdc
Output Voltage Set Point ($V_i = 48$ V, I_o at full load, and $T_A = 25^\circ\text{C}$)	$V_{O\text{ set}}$	4.83	5.0	5.17	Vdc
Output Regulation Line ($V_i = 40$ to 60 Vdc) Load ($I_o = 0.3$ to 3.0 A) Temperature ($T_A = 0$ to 70°C) (see Figure 2)		—	—	0.10	%
		—	—	0.40	%
		—	—	50	mV
Output Ripple and Noise Voltage RMS Peak-to-Peak (5 Hz to 20 MHz)		—	—	25	mV rms
		—	60	100	mV p-p
Output Current	I_o	0.3	—	3.0	A
Output Current Limit Inception ($V_o = 4.5$ V) (see Figure 3)		—	3.6	—	A
Output Current Limit ($V_o = 1.0$ V) (see Figure 3)		3.0	4.4	6.0	A
Output Short-Circuit Current ($V_o = 250$ mV) (see Figure 3)		—	5.6	—	A
Efficiency ($V_i = 48$ V, I_o at full load, and $T_A = 25^\circ\text{C}$) (see Figure 4)	η	78	80.5	—	%
Dynamic Response ($\Delta I_o / \Delta t = 1$ A/10 μs , $V_i = 48$ V, and $T_A = 25^\circ\text{C}$)					
Load Change from $I_o = 1.5$ A to 2.25 A					
Peak Deviation		—	95	—	mV
Settling Time ($V_o < 10\%$ of peak deviation) (see Figure 5)		—	1.25	—	ms
Load Change from $I_o = 1.5$ A to 0.75 A					
Peak Deviation		—	90	—	mV
Settling Time ($V_o < 10\%$ of peak deviation) (see Figure 6)		—	1.2	—	ms
Isolation					
Isolation Capacitance		—	1265	—	pF
Isolation Resistance		10	—	—	M Ω

10-15
WATTS

T-57-11

General Specifications

Parameter	Symbol	Min	Typ	Max	Unit
Calculated MTBF (80% full load and case temperature = 40°C)		900,000			hours
Weight		—	—	3.2	oz.

Feature Specifications

Unless otherwise indicated, specifications apply over all operating input voltage, resistive load, and temperature conditions. (See Feature Descriptions section for further information.)

Parameter	Symbol	Min	Typ	Max	Unit
Remote On/Off, Level Controlled (40 V < V _I < 60 V)					
Voltage Level High — Unit Off	VON/OFF	2.0	—	8.0	V
Source Current		0.6	—	3.5	mA
Voltage Level Low — Unit On	VON/OFF	—	—	0.9	V
Leakage Current		—	—	0.2	mA
Turn-On Time (V _I = 48 V, T _A = 25°C, I _O = 80% full load, and V _O within ±1% of steady-state)		—	5.4	85	ms
Output Voltage Overshoot (see Figure 7)		—	400	—	mV
Output Overvoltage Clamp		5.6	6.3	7.0	V

T-57-11

Characteristics

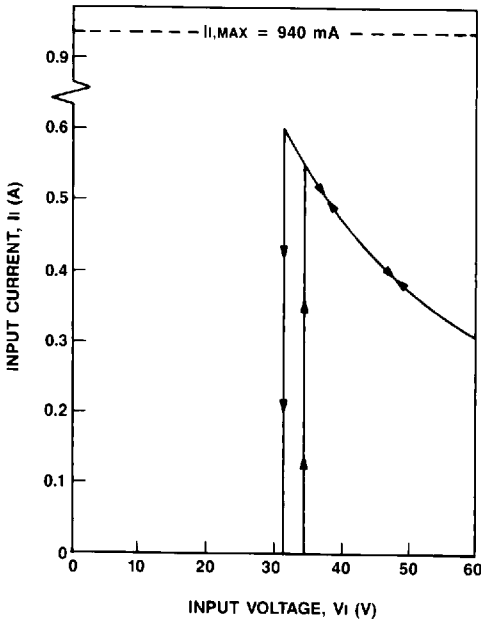

Figure 1. Typical Input Characteristic with a Resistive Load of $I_O = 3.0$ A and $T_A = 25^\circ\text{C}$ (Arrows Indicate Hysteresis)

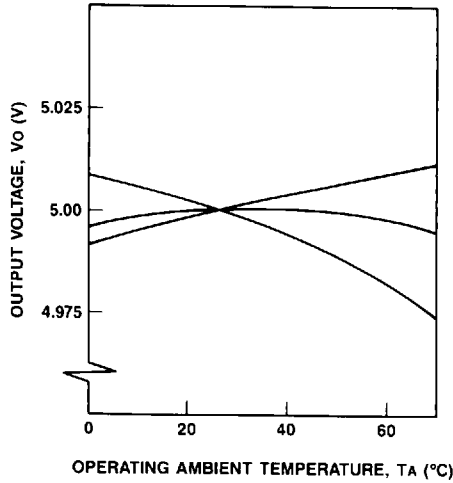

Figure 2. Typical Output Voltage Variations Over Operating Ambient Temperature Range at Full Load and with $V_i = 48$ V

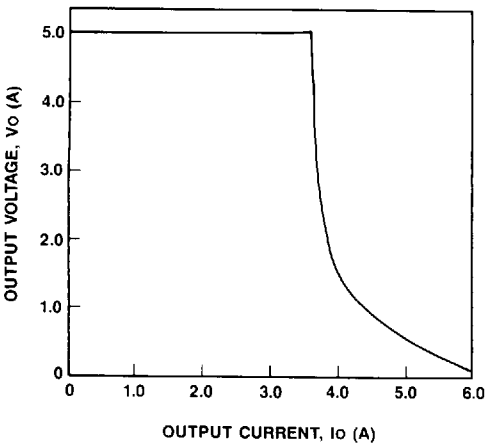

Figure 3. Typical Output Characteristic with $V_i = 48$ V and $T_A = 25^\circ\text{C}$

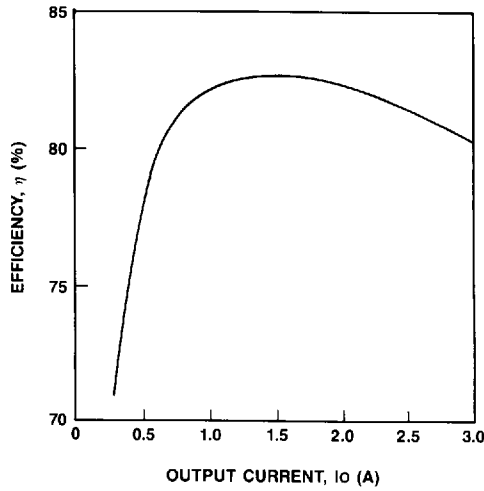

Figure 4. Typical Converter Efficiency as a Function of Output Current with $V_i = 48$ V and $T_A = 25^\circ\text{C}$

10-15
WATTS

T-57-11

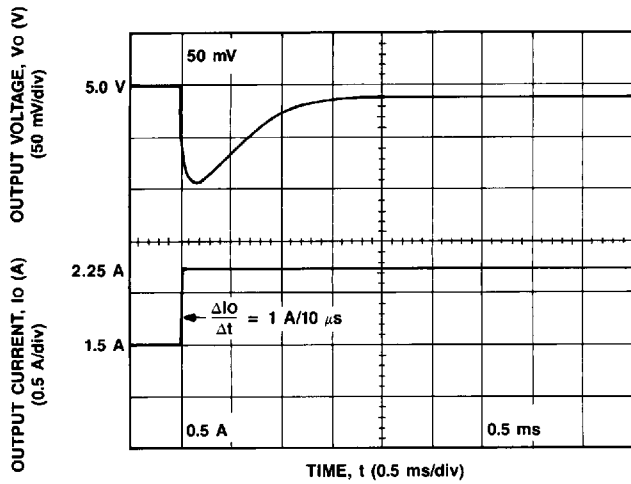

Figure 5. Typical Output Voltage Waveform for a Step Load Change from 50% to 75% of Full Output Power with $V_I = 48\text{ V}$ and $T_A = 25^\circ\text{C}$

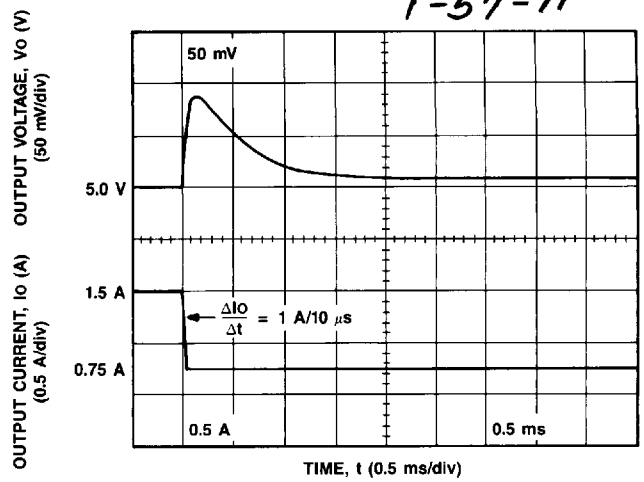

Figure 6. Typical Output Voltage Waveform for a Step Load Change from 50% to 25% of Full Output Power with $V_I = 48\text{ V}$ and $T_A = 25^\circ\text{C}$

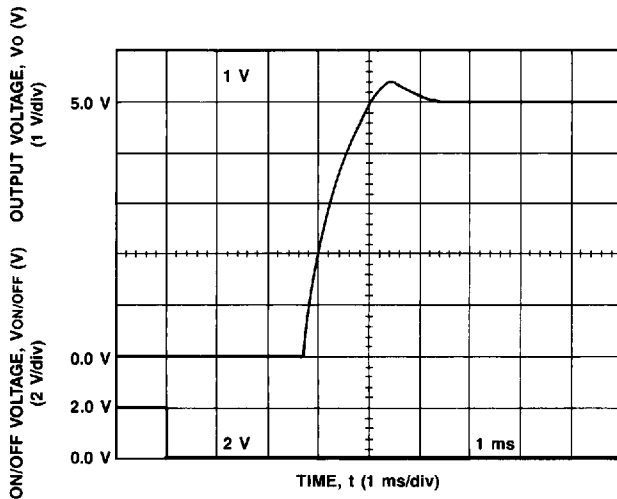
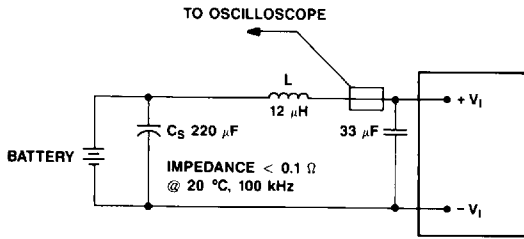

Figure 7. Typical Output Voltage Start-Up Waveform From Remote On/Off, at 80% of Full Load with $V_I = 48\text{ V}$ and $T_A = 25^\circ\text{C}$

T-57-11

Test Configurations



Note: Input reflected ripple current is measured with a simulated source impedance of 12 μH. Capacitor Cs will offset possible battery impedance. Current is measured at the input of the module.

Figure 8. Input Reflected Ripple Test Set-Up

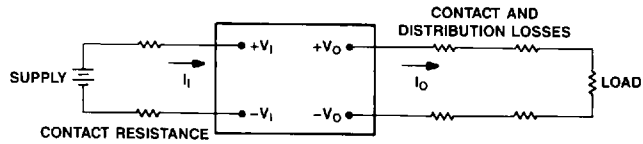

Note: All measurements are taken at the module terminals with sense pins connected directly to the module output pins. When socketing, place Kelvin connections at module terminals to avoid measurement errors due to socket contact resistance.

$$\eta = \frac{[+Vo - (-Vo)] Io}{[+Vi - (-Vi)] Ii}$$

Figure 9. Output Voltage and Efficiency Measurement Test Set-Up

10-15
WATTS

T-57-11

Feature Descriptions

Remote On/Off

The voltage potential between terminals ON/OFF and $-V_I$ turns the power module on and off. The user must furnish a supply with two voltage levels. An applied voltage between 2.0 V and 8.0 V with a source current between 0.5 mA and 3.5 mA is required to turn the unit off. A voltage of less than 0.9 V will keep the power module on. The module may be run with the ON/OFF terminal left open.

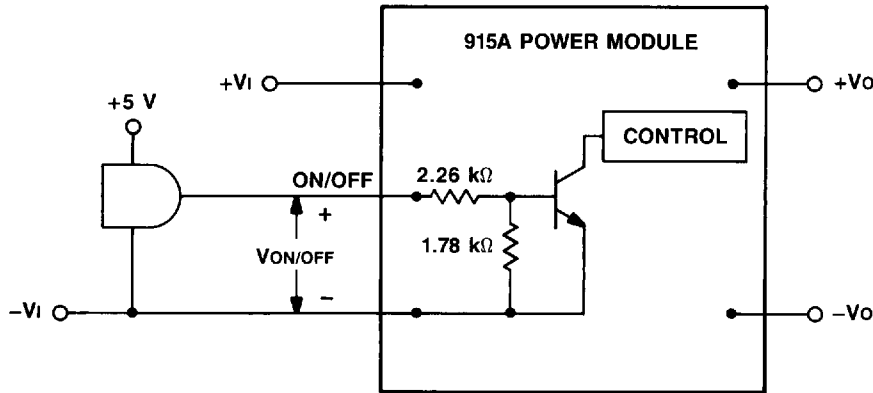

TTL On/Off Requirements:
Disable = TTL logic 1
Enable = TTL logic 0

Figure 10. TTL On/Off Circuit

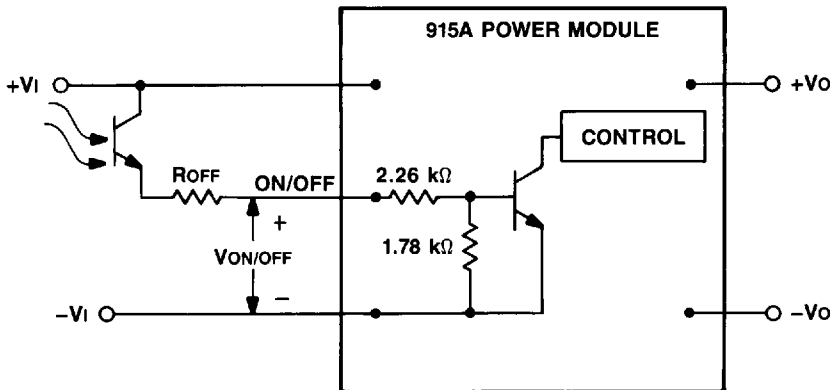

Line Driven On/Off Requirements:
 $15\text{ k}\Omega \leq R_{OFF} \leq 33\text{ k}\Omega$

Figure 11. Line Driven On/Off Circuit

Note: Damage to the 915A Power Module can occur if $V_{ON/OFF}$ exceeds 10 Vdc.

T-57-11

Output Overvoltage Clamp

The output overvoltage clamp consists of control circuitry that monitors the voltage on the output voltage terminals. The circuit consists of a second totally independent control loop with a higher set point of nominally 6.3 V. This feature provides a redundant voltage-control capability that reduces the risk of output overvoltage.

Current Limit

Each unit is equipped with internal current limiting. The module is designed to endure current limiting for an unlimited time. The module will operate normally once the output current is brought back into the specified range.

10-15
WATTS

T-57-11

Outline Diagram

Dimensions in inches and (millimeters)

Top View

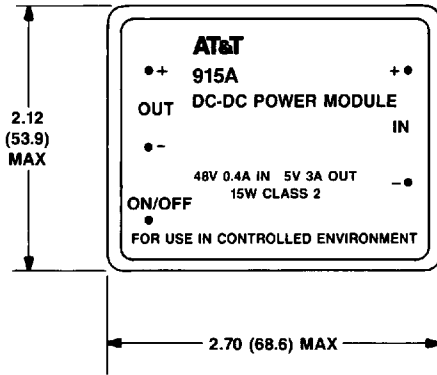

Side View

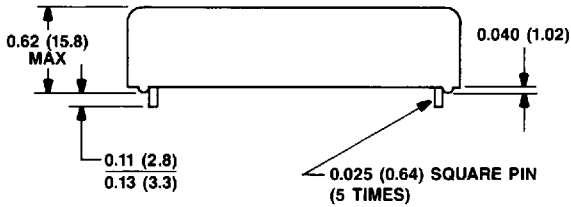

Bottom View

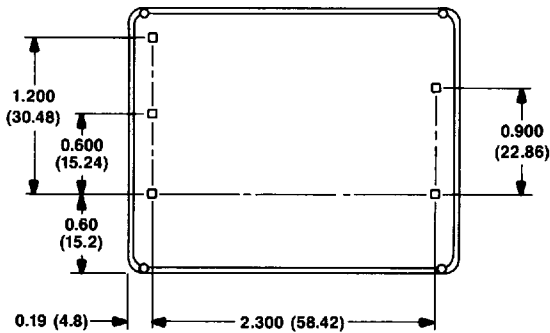

T-57-11

Recommended PCB Hole Pattern (Component-side footprint)

Dimensions in inches and (millimeters)

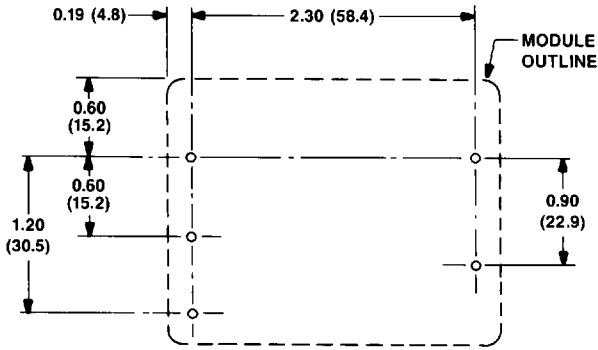

Tolerances: x.xx ±0.020 inch (0.51 mm), x.xxx ±0.010 inch (0.25 mm)

10-15
WATTS

AT&T Comcode 104386149